

# Development of Biped Walking Robot

S.Pavan kalyan<sup>1</sup>,K Archana<sup>2</sup>,M Bhaskar<sup>3</sup>

<sup>1,2,3</sup>Assistant Professor Department of Mechanical Engineering,

St. Martin's Engineering college Dhulapally, Secunderabad – 500100.

Email: pavanme@smec.ac.in

This presents developmental of a simple bipedal walking robot. The robot replicates the walking style of a human particularly walking upright, these robots are engineered to perform tasks and navigate environments in a manner like humans. The robot is built with light-weight Aluminium sheets which act as the structural members and housing the servos. An Arduino controller produces intelligent commands to the servos for walking. The Arduino board serves as the brain of the robot, controlling the movements of the servo motors through carefully crafted algorithms. Bipedal working robots find applications in various fields, including research and development, human-robot interaction, medical rehabilitation, search and rescue missions, and entertainment, ushering in a new era of robotics that aims to coexist harmoniously with humans and enhance our daily lives

## Keywords

Bipedal Walking Robot, Arduino, Algorithms

## 1. Introduction:

A biped walking robot is a type of robotic system designed to replicate the walking abilities of humans or animals, typically with two legs. These robots are a subset of humanoid robots and are engineered to achieve a wide range of tasks, from navigating challenging terrains to performing various activities in a human-like manner. The concept of bipedal locomotion in robots has gained significant attention in the field of robotics due to its potential applications in areas such as search and rescue, healthcare, manufacturing, and entertainment.

Despite the technical challenges associated with bipedal locomotion, advancements in robotics and artificial intelligence have enabled the development of increasingly capable and versatile biped walking robots, with the potential to revolutionize industries and improve our daily lives.

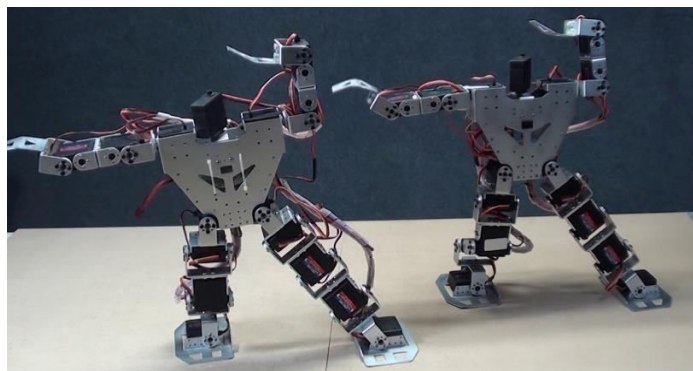

Fig 1.1 Biped Walking Robot

## 2.Methodology:

A biped walking robot is a type of robotic system designed to replicate the walking abilities of humans or animals, typically with two legs. These robots are a subset of humanoid robots and are engineered to achieve a wide range of tasks, from navigating challenging terrains to performing various activities in a human-like manner. Mechanical Design: The mechanical design of biped robots plays a critical role in their performance. Compliance, lightweight materials, and joint kinematics are essential factors in achieving natural and dynamic movements



Fig 2.1 Design Of Biped Walking Robot

### 2.2 FABRICATION OF VARIOUS LINK

The Links below are of feet and hip, the feet provides a stable balance to whole body whereas the hip joint help in effective walking. Despite the technical challenges associated with bipedal locomotion, advancements in robotics and artificial intelligence have enabled the development of increasingly capable and versatile biped walking robots, with the potential to revolutionize industries and improve our daily lives.



Fig:2.2 Links Of Biped Walking Robot



**3.Signal to Servo Motor Board :** The Arduino after getting command from user translates the electric signals to servo board where all servo motors are attached with help of pin. Each servo motor has unique pin and therefore command is given to a particular pin to move servo motor. Human-Inspired Gait: Emulating human walking patterns is a common goal, as it leads to more natural and efficient movements. The study of human biomechanics and motion capture is frequently used to inform robot gait design. The solutions developed to address their problems, and the multifaceted research landscape within this field. As technology continues to advance, bipedal robots are likely to become more capable and versatile, potentially transforming various industries and applications in the future

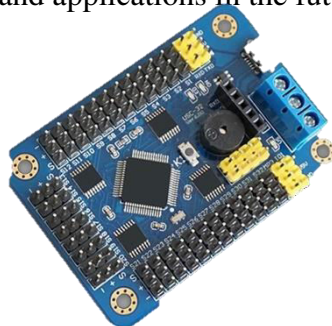

Fig.2.5 Servo Pin Board

**4.Circuit Junction :** Servo board gives Electric current to the particular servo motor which has to be moved by junction of circuit which guides the current to particular motor. This stages is very important as slight change or fault here will not give desirable result. Some serial Arduino boards contain a level shifter circuit to convert between RS-232 logic levels and transistor–transistor logic (TTL) level signals. Current Arduino boards are programmed via Universal Serial Bus (USB), implemented using USB-to-serial adapter chips such as the FTDI FT232.

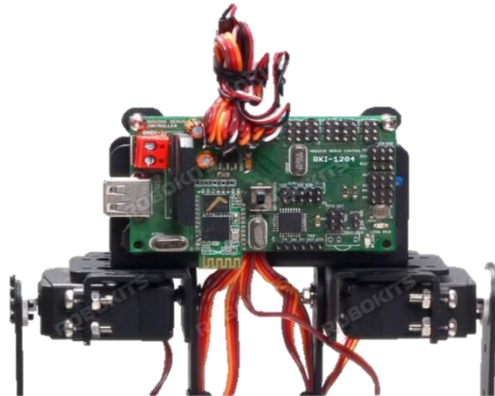

Fig.2.6 Circuit Junction

**5.Servo Motors:** The electrical energy coming by the circuit junction to the desired Servo motor and then the motor transform the electric current into mechanical motion and coming by the circuit junction gives the desired motion given by the User.



### 3.1 COMPONENTS OF BIPED ROBOT



Fig 3.1 Servo Motors

The Servo detects the operation error of a mechanism, provides feedback and corrects faults. The servo motor can have alternating current (AC), direct current (DC) or stepper motors. In addition to these, there are drive and control circuits. Servomotors are the kinds of motors that can fulfil the commands we want. They can operate steadily even at very small or very large speeds. In these motors, the large moment can be obtained from the small size. Servo motors are used in control systems such as fast operation, excessive axis movement, condition control and so on.

#### 3.1.1 Arduino UNO

Arduino is an open source computer hardware and software company, project, and user community that designs and manufactures single-board microcontrollers and microcontroller kits for building digital devices and interactive objects that can sense and control objects in the physical world. The project's products are distributed as open-source hardware and software, which are licensed under the GNU Lesser General Public License (LGPL) or the GNU General Public License (GPL), permitting the manufacture of Arduino boards and software distribution by anyone.

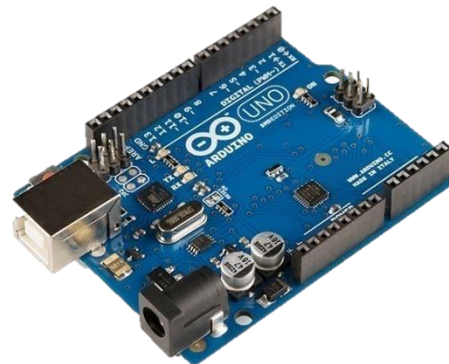

Fig 3.1.1 Arduino UNO

**Power supply**

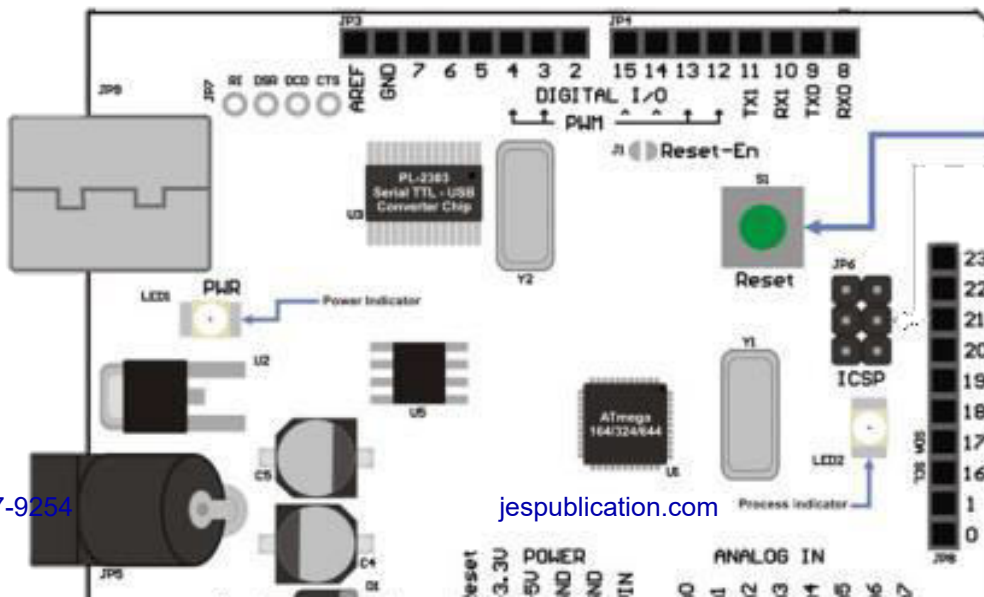

Fig 3.1.2 Power Supply

The power supply selected for feeding the control circuit of the servomotors is capable of delivering the same current even if all the synchronous servomotors are operating. When all servo motors are operated at the same time, they draw 0.5A current. In addition, 5 V was needed for the Arduino used for robot movement in the project. Energy Management: Energy management systems, such as Battery Management Systems (BMS), are used to monitor and regulate the power supply. This requirement is provided by a 5V power supply. Batteries are a crucial component of biped walking robots, just as they are for many other types of robots. These batteries provide the necessary power to drive the robot's motors, control systems, and other electronic components. Batteries: As mentioned in the previous response, batteries are a common and essential power source for biped walking robots. They provide the electrical energy required for the robot's motors, control systems, sensors, and other electronic components. High-capacity lithium-ion or lithium-polymer batteries are often used. Power Distribution:

**3.1.2 Servo Pin Boar:**

The Servo pin board exposes most of the microcontroller's I/O pins for use by other circuits. The Diecimila, Duemilanove, and current Uno provide 14 digital I/O pins, six of which can produce pulse-width modulated signals, and six analog inputs, which can also be used as six digital I/O pins. These pins are on the top of the board, via female 0.1-inch (2.54 mm) headers. Several plug-in application shields are also commercially available. The Arduino Nano, and Arduino-compatible Bare Bones Board and Board uino boards may provide male header pins on the underside of the board that can plug into solderless breadboards.



### 3.1.3 Robot Frame

The frame or chassis of a bipedal robot is the structural component that provides support, stability, and a foundation for all other robot components. It is essential for maintaining the robot's structural integrity and ensuring that it can perform stable and balanced locomotion. Here are some key considerations and characteristics of a biped robot frame or chassis:

**Material Selection:** The choice of materials for the frame is crucial. Common materials used in biped robot frames include lightweight metals like aluminum and titanium, carbon fiber composites, and high-strength plastics. The material selection is often based on factors such as strength, weight, and cost.

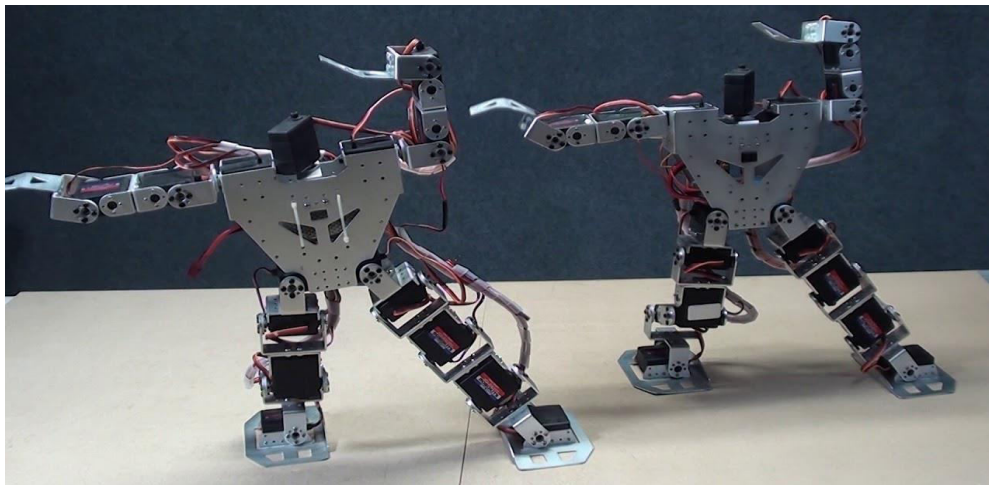

Fig : Frame Chasis

### 3.1.4 WORKING MECHANISM

A biped walking robot works by imitating human-like walking through a combination of mechanical components, sensors, and control algorithms. Here is an overview of how a biped walking robot functions:

**Mechanical Structure:** A biped walking robot typically has two legs, each equipped with multiple joints and links that mimic the structure of human legs. These joints provide mobility and flexibility for walking and other movements.

**Actuators:** Electric motors or other actuators are used to control the joints in the robot's legs. These actuators generate the necessary forces and torques to move the robot's limbs, allowing it to take steps and perform walking motions.

**Sensors:** A variety of sensors are employed to monitor the robot's state and its environment: Inertial Measurement Units (IMUs) are used to measure the robot's acceleration and orientation, providing information about its body's position and orientation in space.

Force and torque sensors in the feet measure ground reaction forces and moments, helping the robot maintain balance and adjust its movements. Vision systems, such as cameras and LIDAR, enable the robot to perceive its surroundings and identify obstacles or terrain variations.

Encoders on the joint motors provide feedback on the positions and velocities of the robot's joints. Gait Generation: Gait generation algorithms determine the leg movement patterns and step sequences required for walking, running, or other locomotion modes.

Control Algorithms: Control algorithms are responsible for coordinating the robot's movements to achieve stable and efficient walking. Key control algorithms include

Stabilization Control: This algorithm calculates and controls the robot's center of mass to keep it within the support polygon formed by the feet, adaptability to different ground surfaces. Compliant and articulated feet can improve ground contact and stability ensuring stability. Trajectory Planning: Trajectory planning calculates the desired joint angles and leg movements to achieve a stable and coordinated gait.

Kinematics and Inverse Kinematics: Kinematics and inverse kinematics equations are used to compute the joint angles and positions needed to achieve specific leg movements and body postures while maintaining balance. Feedback Control: Feedback control loops continuously adjust the robot's joint positions, torque commands, and other control parameters based on sensor feedback. These adjustments help maintain balance and stability. Stability and Balance: One of the primary objectives is to achieve stability and balance during walking. Biped robots aim to maintain equilibrium to prevent falling, even in the presence of external disturbances or on uneven terrain. These batteries provide the necessary power to drive the robot's motors, control systems, and other electronic components. Batteries: As mentioned in the previous response, batteries are a common and essential power source for biped walking robots.

#### 4.1 SOURCE CODE:

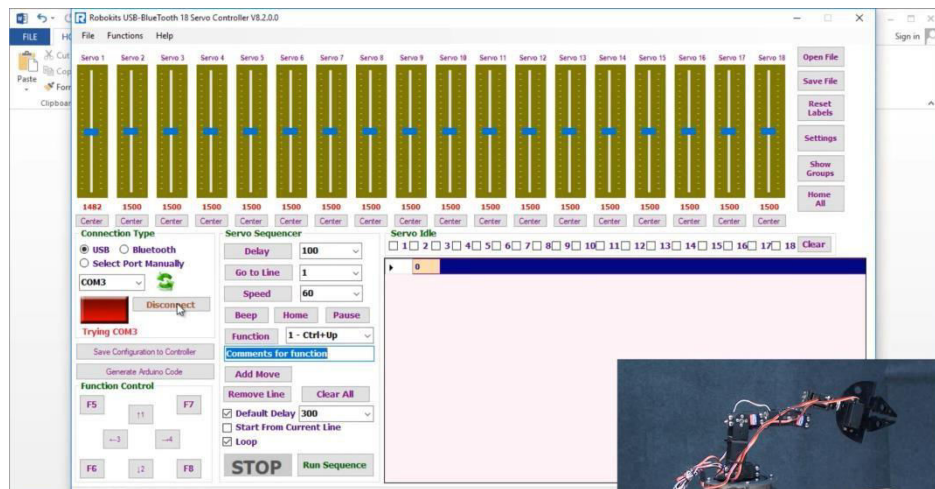

#### Source code for walking

```
#include <Servo.h>

// Define servo pins #define LEFT_HIP_PIN 9
#define RIGHT_HIP_PIN 10

#define LEFT_KNEE_PIN 11

#define RIGHT_KNEE_PIN 12

// Create servo objects
```



```

Servo leftHip, rightHip, leftKnee, rightKnee
// Define initial positions
int hipForwardAngle = 90;
int hipBackwardAngle = 45;
int kneeStraightAngle = 90;
int kneeBentAngle = 45;
// Define step duration and pause between steps int stepDuration = 500; // milliseconds
int pauseDuration = 1000; // milliseconds
void setup() {
  // Attach servos to pins
  leftHip.attach(LEFT_HIP_PIN);
  rightHip.attach(RIGHT_HIP_PIN);
  leftKnee.attach(LEFT_KNEE_PIN);
  rightKnee.attach(RIGHT_KNEE_PIN);
}

void loop() {
  // Move left leg forward
  moveLeg(leftHip,
  hipForwardAngle, leftKnee, kneeBentAngle);
  delay(pauseDuration);
  // Move left leg backward
  moveLeg(leftHip,
  hipBackwardAngle, leftKnee, kneeStraightAngle); delay(pauseDuration);
  // Move right leg forward
  moveLeg(rightHip,      hipForwardAngle,      rightKnee,      kneeBentAngle);
  delay(pauseDuration);

  // Move right leg backward
  moveLeg(rightHip,      hipBackwardAngle,      rightKnee,      kneeStraightAngle);
  delay(pauseDuration);
}

// Function to move a leg forward and backward
void moveLeg(Servo hip, int hipAngle, Servo knee, int kneeAngle) {
  hip.write(hipAngle);
  knee.write(kneeAngle);
  delay(stepDuration);
}

```

#### 4.1.2 source code for Stopping

```
#include <Servo.h>
```

```

// Define servo pins #define
LEFT_HIP_PIN 9
#define RIGHT_HIP_PIN 10

#define LEFT_KNEE_PIN 11
#define RIGHT_KNEE_PIN 12

// Create servo objects
Servo leftHip, rightHip, leftKnee, rightKnee;

// Define stop positions
int hipStopAngle = 90; // or any other angle that keeps the legs in a stationary position
int kneeStopAngle = 90; // or any other angle that keeps the legs in a stationary position
void setup() {
  // Attach servos to pins
  leftHip.attach(LEFT_HIP_PIN);
  rightHip.attach(RIGHT_HIP_PIN);
  leftKnee.attach(LEFT_KNEE_PIN);
  rightKnee.attach(RIGHT_KNEE_PIN);
}

void loop() {
  stopRobot();
}

// Function to stop the robot

```

```
void stopRobot()
```

### **RESULT:**

Robots are the future of this constantly evolving world. By each day, the new inventions, upgrades, ideas are presented in front of the world, henceforth, the use of Robot in the day to day activities will be incorporated. Biped walking Robot is the most suitable product to go with, as it gives a human feel in its look, working and appearance. This biped robot is equipped with arduino, servo motors, power source etc. The field of biped walking robots has seen continuous advancements and innovations. While I don't have information on developments beyond that date, I can highlight some areas of newness and emerging trends that were shaping the field at that time.

One of the major advantages of this biped walking robot is Human-Like Mobility: Biped robots are designed to imitate the human gait, allowing them to navigate environments and interact with objects designed for humans. The environmental impacts of biped robots are highly dependent on their design, use case, and how they are powered. To minimize negative environmental impacts and enhance the positive ones, it is crucial to consider sustainable design, efficient energy sources, responsible manufacturing, proper disposal, and recycling practices. Additionally, regulatory frameworks and standards for robotics can help ensure that biped robots are developed and operated with environmental considerations in mind.

## CONCLUSION

This project was intended to make a design of a Biped walking Robot. A better design is desired from this project so that the fabrication and development of the Biped walking Robot is made easy. The design consist of a biped walking robot of 17 DOF (degree of freedom) which means 17 joints are present in the robot.

Biped walking robot provides a easiness in day to day working/activities. The regular use of such robot will helps in understanding the working of robot in a more effective manner and also gives us an ideas of up gradation in various fields.

## *FUTURE SCOPE*

The future scope of biped walking robots is quite promising and diverse, with numerous potential applications and advancements in various fields. Here are some key aspects of the future scope of biped walking robots:

- Search and Rescue
- Humanoid Assistants
- Rehabilitation and Physical Therapy
- Manufacturing and Logistics
- Entertainment and Amusement
- Military and Defense
- Astronaut Assistance

## REFERENCES:

1. Introduction to Autonomous Robots by Nikolaus Correll, Bradley Hayes
2. Principles of Robot Motion: Theory, Algorithms, and Implementations by Howie Choset, Kevin Lynch
3. Principles of Robot Motion: Theory, Algorithms, and Implementations by Howie Choset, Kevin Lynch
4. Humanoid Robotics and Neuroscience: Science, Engineering, and Society by Gordon Cheng, Philippe Gaussier
5. Walking: A Complex Tool for Human Evolution by François L. T. Müller and Thomas R. Kivell (Editors)
6. Legged Robots That Balance by Marc Raibert
7. Humanoid Robots: Modeling and Control by Shuuji Kajita, et al.
8. Legged Robots: Aggregation and Locomotion by Max Bernhard
9. Humanoid Robotics: A Reference edited by Ambarish Goswami,
10. Biped Locomotion: Dynamics, Stability, Control and Application by Grigore C. Burdea and Ali K. Ünsal